

A Guide for Rainwater Catchment Systems in the Pacific



Table of Contents

Introduction	3	Water Testing	11-12
What is a rainwater catchment?	3	Water test kits	11
Who has rainwater catchments?	3	Test kit instructions	11
Is rainwater catchment a good idea?	3	Other testing options	12
Can catchment water be used?	3		
Water Quality	4-5	Water Treatment	13-17
What happens if I drink contaminated		Filters	13
water?	4	Disinfections with bleach	14
If my tank is contaminated, why don't I		Is it okay to use bleach?	14
get sick?	4	How do I add bleach to the tank?	14
Is it okay if I only use contaminated water for..		How much bleach do I add?	15
washing?	4	What if I don't know the size of my tank?	15
Doesn't my water filter clean my water?	5	How often should I add bleach to my tank? .	15
How can I tell if my water is contaminated? ..	5	Eliminating the taste and smell of bleach	16
		Why purify catchment water with bleach	16
		Boiling water to purify it	17
		Improving the taste of boiled water	17
		Solar pasteurization	17
System Components	6-9	Rate Your Catchment System	18
Building materials	6	Test Your Knowledge	19
Roofing	6	Document Information	20
First-flush diverter	6		
Gutters	7		
Downspouts	7		
Screens	7		
Tank liners	8		
Type of tanks	8		
Tank covers	9		
Tank foundations	9		
Location of tank	9		
Preventing Contamination	10		
Roof and gutter maintenance	10		
Trimming nearby trees	10		
Tank maintenance	10		
Preventing air-borne contamination	10		

INTRODUCTION

What is a rainwater catchment system?

A collection system that catches, stores, and distributes rainwater for individual household use.



Who has rainwater catchments?

Rainwater Catchment Systems are the primary source of drinking water in the Republic of the Marshall Islands (RMI), the Republic of Palau, and the Federated States of Micronesia (FSM). Sixty-nine percent of the population of RMI, 67% of the population of Palau, and 49% of the population of FSM uses rainwater catchment systems for some or all of their water needs.

Is water catchment a good idea?

With proper design, maintenance, and water treatment, a rainwater catchment system can provide your family with water that is clear, odorless, and relatively free of contamination. This water can be used for drinking, bathing, washing, flushing, laundry, and gardening but if the system is not properly designed and maintained, it can be a source of serious health risks and illness.

It is very important that those using water from a rainwater catchment system understand all of the potential dangers, and the work that must go into maintaining the system. Currently in Palau, there are no government agencies that oversee the health safety of rainwater catchment systems. In the RMI, the local EPA office and the Cooperative Research and Extension Water Quality program provide this service, and in the FSM, the local EPA Offices monitor water catchments, however, the service is provided mainly on the larger islands upon request. It is up to you to maintain the water source so that it is safe for you and your family to use.



Can catchment water be used for drinking and other home uses?

It can be. The quality of rainwater in your country may be excellent, but it can be easily contaminated when it comes in contact with the roof, gutters, and tank of a catchment system. Roofs and gutters need to be routinely cleaned, the tank must be kept clean, and the water must be purified. The quality of the catchment water depends greatly on your commitment to maintaining the system.

WATER QUALITY

Many people choose to use catchments instead of the public supply system to get better quality water. What they don't realize is that the majority of rainwater catchment systems are likely to be contaminated because they aren't properly maintained.

What happens if I drink contaminated water?

Contaminated water can cause very serious illnesses, especially in children and the elderly. Diseases such as Leptospirosis, Salmonellosis, Listeriosis and Giardiasis can be spread through contaminated water.

If my tank is contaminated, why don't I get sick?

Many people believe it is not necessary to disinfect their catchment system because they don't believe they are getting ill from drinking it. Some people can build up immunities to some of the less serious bacterial diseases like Salmonellosis or may not display any symptoms of an infection. Some people have very mild symptoms such as mild diarrhea and upset stomach, which they might attribute to other things. Other people can get seriously ill and perhaps die.

Young children, the elderly, and those with already weakened immune systems (people with cancer or other diseases), are particularly susceptible to illnesses caused by contaminated water. Sometimes illnesses have minor symptoms like diarrhea, cramps, nausea, and headaches. Parents of sick children may just assume their children have the flu or some other illness, when really they are ill from the water. An illness will sometimes go away on its own as the bacteria leaves the body, but it can also become very serious and, in some cases, even lead to death.

Is it okay if I only use contaminated water for washing?

No! Diseases such as Leptospirosis, which is spread by the urine of rats and other mammals, is contracted through skin cuts and soft mucus membranes, like the eyes and groin. This means that even when you are washing your dishes or taking a bath, the *Leptospira* bacteria could enter your body.

WATER QUALITY

Doesn't my water filter clean my water?

No. Common water filters that attach to your faucet will remove dirt and chlorine but do not remove bacteria. Most filters will make the water look clear and taste better, but they do not take out many of the disease causing organisms. A 1-micron filter will remove protozoans like Giardia and Cryptosporidium and some larvae, so 1-micron filters are important to use in addition to chlorine.

How can I tell if my water is contaminated?

The first step is to consider how well you have maintained your system. Ask yourself the following questions:

- Have the roof and gutters of the house been cleaned regularly?
- Has the bottom of the tank been cleaned in the last three years?
- Has a cover been on the tank at all times?
- Has bleach been added to the tank at least once a month?

If you answered “no” to any of these questions, your water is very likely contaminated.



Tank bottoms must be cleaned at least every 3 years. Sediment on the bottom can make your water taste bad and harbor bacteria.



If the roof and gutters of your home have not been cleaned and maintained, your catchment water will be contaminated with dirt and bacteria.

SYSTEM COMPONENTS

When it comes to maintaining a water catchment system that provides clean water, it is important to consider all components of your system from the roof to the faucet.

Building materials

The key to choosing building materials for rainwater catchment systems is to select and use materials that will not leach toxins into the water. Every material that comes in contact with the rainwater needs to be considered. This includes the roof, gutters, screens, downspouts, the tank, and any connecting pipes.

Roofing

The most common type of roofing material used in the islands is galvanized metal. When this type of roofing is used in a water catchment system it must be monitored for the appearance of rust. In order to prevent or stop the rust, the roof can be painted with a non-toxic paint that does not contain fungicides or other poisons such as lead that could leach into the water. After the paint is applied to the roof, water should be diverted from the system and the roof allowed to rinse off for a few weeks until the water is clear and doesn't froth (foam).

Other types of acceptable roofing include concrete and terracotta tiles. All types of roofing require regular cleaning. If chemicals or detergents are used for cleaning, water should be diverted from the catchment tank until the rains wash away all the cleaning agents. Avoid using roofing materials that contain uncovered zinc, asbestos, tar, asphalt, pesticide-treated wood, and any materials containing lead.

First-flush diverter

The first-flush diverter allows most of the dust, debris, bird and animal droppings on the roof to be delivered away from the storage tank. A bend in the pipe prevents the contaminated water from back-flushing into the tank. A small drainage hole can be drilled so that the drainage pipe can empty by the next rainfall. The debris in the drainage pipe should be removed periodically.



Galvanized metal roofs must be kept clean. Cleaning the roof and painting it with non-toxic paint will help keep rust from forming.

SYSTEM COMPONENTS

Gutters

Like roofs, gutters should be made from inert materials such as PVC or plastic. Non-colored materials are best, since many colored plastics contain toxic dye or fungicide. When installing gutters, make sure there is a continuous downward slope toward the catchment tank. Low areas can cause a backflow or puddle, which can collect insects and leaves. This in turn can lead to unsafe water that has a bad taste and color.

Downspouts

The pipes that carry water from the gutter to the storage tank should have a continuous downward slope from the roof to the tank. There should not be any sections where the water pools or does not drain completely. Any piping that allows water to sit stagnate is undesirable, because the pipe is left with standing water between rains. Sludge can collect in this area, and bacteria can grow as the water stagnates, resulting in poor water quality.

Screens

One method to keep leaves and other debris out of the catchment tank is to place screens across the gutters. This minimizes the amount of debris that enters the tank. Screens can also be used to block the downspouts. However, a homeowner must be aware that screens are only effective if they are cleaned and maintained on a very regular basis. Before screening gutters or downspouts, decide if you are willing to clean the screens regularly. For homes with trees around it, this may be as often as once a week.

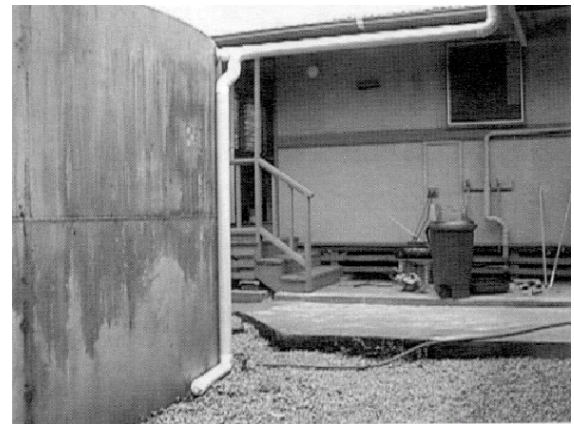

Prevent clogging of the drain hole by removing debris periodically.



The arrow points to an area in the piping that allows water to stagnate, resulting in bacteria growth and poor water quality.

SYSTEM COMPONENTS

Tank liners

Some people use liners to make a drum or other make-shift tanks more suitable for a catchment. It is important to use only liners of food grade quality, since water usually has longer contact with the liner than any other part of the catchment system. Garbage bags and other plastics may be coated with a biocide or other harmful chemicals that could leach toxins into water. Bags need to be replaced periodically due to tearing and wear.

Type of tank

Water tanks can be made from a variety of materials. Concrete, plastic (polyethylene), fiberglass, stainless steel, and even 55-gallon drums are used for rainwater catchments. A plastic tank has the advantage of being inexpensive and portable. Its main drawback is longevity. When exposed to sunlight, plastic and fiberglass tanks eventually weaken so putting them under a roof or cover will increase their life. Fiberglass tanks can be painted but plastic tanks can't. It is important to use food grade quality plastic or fiberglass, otherwise the water will taste bad and it won't be good for you. Cement tanks are more expensive, more difficult to install and, once in place, they cannot be moved. They are, however, very durable and will outlast the plastic tanks by decades. Food grade plastic, fiberglass, or cement are good choices for catchment tanks.

Many people believe that anything that holds water makes a good catchment tank, but this is not true. As with other parts of the catchment system, the tank must be made of non-leaching materials that could affect the quality and safety of the drinking water. For example, wooden barrels and 55-gallon drums are not good choices for water catchment tanks, unless they are lined with a food grade liner. Wood can be difficult to decontaminate, and drums can leach paint and metal into the water. Trash cans can also be dangerous catchment tanks because many are treated with biocides and fungicides to prevent algae growth. These chemicals can leach into the water and cause serious illness.



Metal drums, even when lined with thin plastic, do not make good catchments because bits of plastic, metal, and paint leach into the water.

SYSTEM COMPONENTS

Tank covers

Water storage tanks must be completely covered with a solid material. A cover is essential to keep out:

- sunlight, which can make algae grow
- dirt and floating particles, which can affect the taste and quality of the water
- rats, birds, insects, lizards, etc, whose waste can spread serious diseases
- mosquitoes, who breed in open water
- organic rubbish, which can carry dangerous bacteria to the water and also lead to foul waste.

The more you protect stored water from contamination, the better it will be. *Covering your catchment tank is an important thing you can do to protect the quality of your water.*

Keep the tank lid clean and free of clutter.

Tank foundations

The type of foundation needed under a tank depends on what type of tank you put in. A concrete base is the preferred base because it will keep the tank level and safe from punctures. If the tank is put directly on the ground, the soil directly under it should be compacted and free from sharp objects. Usually a layer of fine sand is used directly under the liner. The ground should be routinely inspected to make sure that it is not being washed away during rains or overflows. Erosion could lead to the tank leaning, and eventually collapsing.

Location of tank

When setting up a storage tank, you need to take a number of things into consideration. The tank should be close enough to the house to be able to run a down-sloping pipe from the roof to the tank. Water runoff should not enter septic system drain fields. The tanks should be in a location where overflow and drainage does not affect the foundations of any structures. If prevailing winds blow mostly from one direction, you may want to shelter the tank on the leeward side of the house. If the tank does not have a solid cover, it should be placed in an area away from an outside kitchen that uses firewood and away from overhanging trees, otherwise debris can get into the tank.



This concrete foundation is appropriate because it keeps the tank level.

PREVENTING CONTAMINATION

Your efforts to keep the catchment system free from contamination in the first place is one of the most important things you can do to improve your water quality.

Roof and gutter maintenance

Most contaminants in your tank wash in from your roof's surface. Waste from birds, rats, cats, and lizards wash into your tank, along with leaves and other debris. This introduces harmful bacteria into your water system which can cause serious illness. In order to avoid this, routinely sweep your roof and remove debris from gutters.

Trimming nearby trees

Tree branches and bushes that hang over the roof of your home give rats, cats, and lizards direct access to your roof. Trim all tree branches that hang over your roof, or are directly adjacent to it.



Trim tree branches to avoid giving rats, cats, and lizards access to your roof.



Open burning causes particles to collect on your roof that are later washed into your tank.

Tank maintenance

All tanks eventually build up a sludge layer on the bottom of the tank. It comes from leaves, dirt, and other debris that washes from your roof and is carried by the water into your tank. Because the sludge can be a breeding ground for microorganisms, this layer needs to be cleaned out regularly. For people who maintain their roofs and gutters, the tank may only need to be cleaned out every three years. For those that are less diligent about maintaining their catchment system, tanks should be cleaned out at least once a year.

Preventing air-borne contamination

Open burning of garbage creates small and harmful debris particles that can either enter directly into your tank, or fall onto your roof where it will eventually be washed into the tank. It is also detrimental to the environment and people's health.

WATER TESTING

Water test kits

If you do an adequate job maintaining your system but are unsure of the water quality, a Water Test Kit is a good option for you. Because most illnesses are caused by fecal bacteria, test kits detect presence of indicator bacteria that come from the intestines. If you have the indicator bacteria in your water that means that you have fecal bacteria in your water, which are very harmful and cause disease. Your water should be free of fecal contamination. Contact either your local Land Grant College or your local health office to find out where you can get home test kits.

When you receive a test kit, it will consist of a small jar with pieces of paper in it. These pieces of paper become black if the water is contaminated. You fill the jar with water from your catchment tank, leaving the paper inside. Sometimes the jar has powder (media) inside instead of a paper strip and all the water will turn black if it is contaminated. There are also test kits that contain a sterile plastic bag and a plastic pillow of media. If you use these tests you wipe the plastic pillow with alcohol and wipe your scissors to sterilize them, then cut open the pillow and pour the media into the bag. Add the water to the bag and follow the test kit instructions.

For all types of tests it usually takes from 24 to 48 hours for the water to change to a black color if it is contaminated. If the water stays yellow, then it does not have fecal contamination.

Test kit instructions

1. Remove the cap from the jar. Fill the jar with catchment water, leaving the paper inside. Or add water and growing media into the sterile bag provided, close the bag securely with the side tabs.
2. Leave the jar in a dark place, like a cupboard or in a dark box, at a room temperature, for 24 to 48 hours.



The bottle on the left is safe to drink. The bottle on the right is contaminated with fecal coliform bacteria.



The two kits on the left (black and brownish) are positive. The two kits on the right (turbid and clear with light precipitate) are negative.

WATER TESTING

3. If the water in the jar or bag remains clear to yellow after 48 hours, the water contains no fecal bacteria indicators and is free of fecal contamination.
4. If the water has turned black, or it has black granules on the bottom, it is contaminated and your water must be purified before being used.
5. Dispose of the test according to instructions.

Other testing options

Additional tests should be done if someone in the household is ill and the water is suspected of being the cause. For more information on who can provide additional water testing services, contact your local Environmental Protection Agency at the addresses listed below:

Republic of Marshall Islands, Environmental Protection Authority
Box 1033
Majuro, MH 96960
Tel: (692) 625-3035
Fax: (692) 625-5202
General E-mail: eparmi@ntamar.com

Federated States of Micronesia, Pohnpei Environmental Protection Agency
P.O. Box 312
Kolonia, Pohnpei, FM 96941
Tel: (691) 320-2927
Fax: (691) 320-2927

Federated States of Micronesia, Chuuk Environmental Protection Agency
P.O. Box 189
Weno, Chuuk FM 96942
Tel: (691) 330-4158
Fax: (691) 330-2613
General E-mail: cpiccap@mail.fm

Federated States of Micronesia, Yap State Environmental Protection Agency
P.O. Box 178
Colonia, Yap FM 96943
Tel: (691) 360-2113
Fax: (691) 350-3292
General E-mail: epayap@mail.fm

Palau, Environmental Quality Protection Board
P.O. Box 8086
Koror, RP 96940
Tel: (680) 488-1639
Fax: (680) 488-2963
General E-mail: eqpb@palaunet.com

WATER TREATMENT

There are several reasons to begin a water treatment program for your water catchment system. The most important reason is to kill dangerous bacteria that may be in the water. Treatment can also improve the color, odor and taste of your water. A treatment program may include combination of filters, disinfection with bleach and/or boiling water.

Filters

There are three basic types of filters commonly used with water catchment systems. The first is a piece of fabric placed over the out-flow spout of the tank. This is used by many people to remove dirt and other debris from the water. Although it can help improve the clearness and taste, this type of filter is a big problem because it isn't changed often enough. The cloth provides a perfect place for bacteria to grow and then get into the water. So even if your tank water is clean, you are contaminating the water that comes through the fabric. It would be best to use a mesh screen made out of wire or plastic and to clean it out regularly. If you still want to use a fabric filter then you should make sure that a residual of chlorine is coming through the filter so whatever bacteria is in the fabric is getting treated.

The second type of filter is the type placed in the pipeline or attached to your sink's faucet. This is usually composed of filtering material and/or carbon and is a good way to remove dirt and chlorine from the water. It does not, however, remove bacteria, so it cannot be used as a means of purification. Like the fabric filter on the intake, bacteria can begin to grow on the filter and contaminate the water. It is important that this filter is changed in accordance with the manufacturer's recommendation.

The third type of filter that is used for drinking water is a 1-micron filter. These filters have very tiny holes and are used to remove protozoan cysts like Giardia, which chlorine doesn't kill. When you are looking for a 1-micron filter look for a filter that says it removes or reduces cysts. This is usually used in addition to the sediment filters mentioned above.



Dangerous bacteria can live in fabric filters. Use a wire mesh screen instead.



Carbon filters help your water taste better but they do not remove bacteria from the water.

WATER TREATMENT

Disinfection with bleach

All catchment water must be purified before being consumed. Unscented laundry bleach is one way to do this. It is an inexpensive way to kill many of the bacteria and algae that may be present in your water storage tank. Laundry bleach is a form of chlorine, which is used in water systems throughout the world.

Is it okay to use bleach (chlorine)?

Although many people are concerned about the safety of bleach in drinking water there are far greater risks of getting a gastrointestinal illness from drinking nonchlorinated water from a catchment system. Bleach has been used as a disinfectant for water for many years. It is best to use plain bleach, not scented or thick varieties. The chlorine in bleach is called sodium hypochlorite. You may be able to find food grade solid bleach. This would be called calcium hypochlorite and it is stronger than the liquid bleach. Do not use swimming pool chlorine because it contains toxic ingredients.

How do I add bleach to the tank?

To add the bleach to your tank, measure it with a measuring cup and pour it into a bucket of clean water. Then pour this bucket into the tank. This helps with even distribution of the bleach. Let the tank sit for a few hours before using the water in order to ensure the bleach is completely distributed. For smaller volume, 1-55 gallons, the bleach treatment time could be reduced to one hour. Try to spread it around if you can.



Using the table to the right, measure the appropriate amount of bleach using a standard measuring cup.

If you can get some sense of bleach at the faucet, either by smelling it or tasting it, then you have enough bleach in your water. If you have no sense of bleach at your tap, then you need to add more. If the bleach is really strong then you can uncover the tank for a few hours in the sunlight and much of the bleach will escape.

<u>Water Volume</u>	<u>Regular Bleach</u>
1 gallon	3 drops
5 gallons	10 drops or 1/4 teaspoon
55 gallons	2 teaspoons
100 gallons	1 tablespoon
200 gallons	2 tablespoons
500 gallons	5 tablespoons or 1/3 cup
850 gallons	10 tablespoons or 2/3 cup
1000 gallons	12 tablespoons or 3/4 cup

WATER TREATMENT

How much bleach do I add?

The previous table lists approximate amounts of bleach that should be added to your tank. This is based on the assumption that the tank is full, clean, and has a cover. If your tank is not clean, you must clean it out in order for the bleach to be effective. Otherwise, your tank could remain contaminated. If the tank is not covered the bleach will not stay in the tank very long and you will not be protected from bacteria when the bleach is gone.

What if I don't know the size of my tank?

You can measure your own tank using the calculations below, or you can ask for assistance from the EPA's Pacific Islands Office at the contact information on page 12 of this manual.

Note: Assuming the tank is full, the dimensions are of the area that water occupies.

- **Calculation of Water Volume**
- **A tank is 10ft wide and 12ft long and the depth of water is 10ft.**

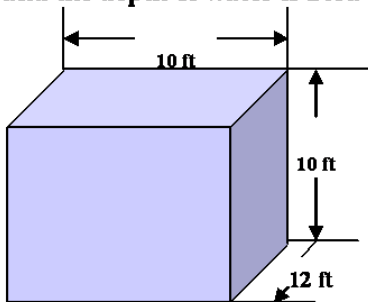

- **Volume = (length)(width)(depth)**
- **= (12 ft)(10 ft)(10 ft)**
- **= 1200 cu ft x 7.48 gallons**
- **= 8796 gallons**
- **1 cubic foot = 7.48 gallons**

- **Calculation of Water Volume**
- **The diameter (D) of a tank is 10ft and the depth of water is 12ft.**

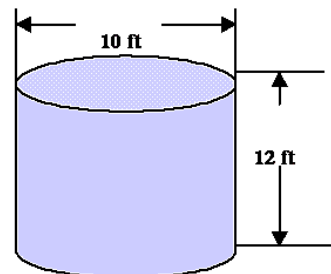

- **Volume = (0.785)(D)(D)(depth)**
- **= (0.785)(10ft)(10ft)(12ft)**
- **= 942 cu ft x 7.48 gallons**
- **= 7046 gallons**
- **1 cubic foot = 7.48 gallons**

How often should I add bleach to my tank?

Regular, unscented bleach should be added to the tank on a monthly basis or, during very rainy periods, as often as once a week. The objective is to keep at least 1.0 part per million (ppm) of residual chlorine in the tank. At this level, bacteria entering the system will be killed and the presence of chlorine is slightly noticeable in the water. If you can't smell or taste the chlorine in the tank, you should add more.

WATER TREATMENT

Eliminating the taste and smell of bleach

Even in municipal systems, chlorine can give an odor and taste to the water that is objectionable to many people. Chlorine also masks the natural mineral flavor of water. These problems, however, are easy to get rid of. Chlorine breaks down very quickly in water, especially when exposed to air. In order to get rid of the chlorine, pour the water into a clean container, and let the container sit at room temperature or in the refrigerator overnight. By the next day, no chlorine will be left in the water, but it will still be safe to drink.

Why purify my catchment water with bleach

The number one reason to chlorinate your catchment system is because it kills *Leptospira* bacteria. *Leptospira* is found in the urine of animals, such as rats, and is the most widespread disease in the world. This disease is usually contracted by skin contact, not through the digestive system. So even if you don't drink your catchment water, you can still be exposed when washing your hands, your car, taking a bath, etc. Symptoms of Leptospirosis include fever, chill, headache, muscle ache, vomiting and/or diarrhea. It affects the liver and kidney and can lead to death if not treated.



Leptospira bacteria is spread to humans through skin contact with water contaminated with animal urine and causes an infectious disease that affects the liver and kidneys.

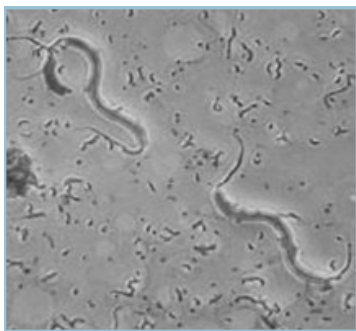

Fecal bacteria has been found in rainwater catchments across the Pacific.

The second reason to consider chlorination of your tank is that no matter how clean you keep it, your tank is likely contaminated with fecal bacteria that washes in from the roof. Fecal bacteria are organisms that are present in the feces of all warm-blooded animals, humans, and even in some reptiles. Drinking water that is contaminated with fecal bacteria can cause serious illness.

WATER TREATMENT



Bringing water to a boil kills harmful bacteria.

Boiling water to purify it

Another option for purifying water is to boil it. Heating your catchment water until it comes to a full boil kills harmful bacteria in the water, making it safe for drinking, cooking, and any other uses. Although this is not a practical means of purifying large amounts of water, it is an easy way to ensure the water you use is free of disease causing bacteria and microorganisms.

Improving the taste of boiled water

Once water has been boiled, it has a rather flat taste to it. This is because all of the oxygen has bubbled out of the water. To put the oxygen back in, simply pour the water back and forth between two containers several times. The water will immediately taste better.

Solar pasteurization

Solar pasteurization units are a good option for purifying catchment water. These systems automatically pump water from your catchment through a solar panel that disinfects the water and kills the bacteria using solar heat. The water is then pumped into a second clean tank, where you can then safely use it. Panels must be mounted on the roof or another location where it is fully exposed to the sun.



Pouring water that has been boiled back and forth between two containers will make it taste better.

A solar pasteurization unit uses the sun's heat to purify catchment water.

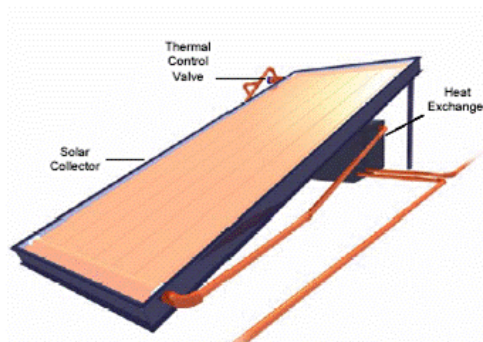

RATE YOUR RAINWATER CATCHMENT SYSTEM

Below is a list of questions that summarize the information contained in this manual. Rate your catchment system on each of the sections below. For each question you answer “yes” to, give yourself 1 point. If you answer “no”, give yourself 0 points.

Section 1: System Set-Up:

1. Is my roof free of rust? ____
2. Are my gutters made out of plastic or PVC? ____
3. Is my tank designed to be a catchment tank (not a drum or a garbage can, etc)? ____
4. Does my tank have a cover on it? ____
5. Is your piping system free of any area where stagnant water can remain between rainfalls? ____

Add up your points for Section 1 and write the number down: _____

Section 2: Maintenance:

1. Do I regularly clean my roof and gutter so that leaves don't get into the tank? ____
2. Have I trimmed all the trees from around my roof and tank so that rats, cats, and lizards can't get access? ____
3. Have I emptied and cleaned my tank within the last 3 years? ____
4. Do I take all of my garbage to the dump instead of burning it? ____
5. Do I keep the out-flow spout filter clean? ____

Add up your points for Section 2 and write the number down: _____

Section 3: Water Quality:

1. Have I had my water tested in the last 2 years? ____
2. Do I add bleach to my system regularly? ____
3. Is it true that no one in my household has frequent diarrhea, vomiting or nausea? ____
4. When in doubt of my catchment's water quality, do I boil my water? ____

Add up your points for section 3 and write the number down: _____

Now, add up your points from each section and write the number down: _____.

How did you do on this short quiz?

14-12 points = A / Excellent
5-2 points = D / Poor

11-9 points = B / Very Good
1 or 0 points = F / Unsatisfactory

8-6 points = C / Satisfactory

How many things are wrong with this catchment system?

(answers on side of the page)

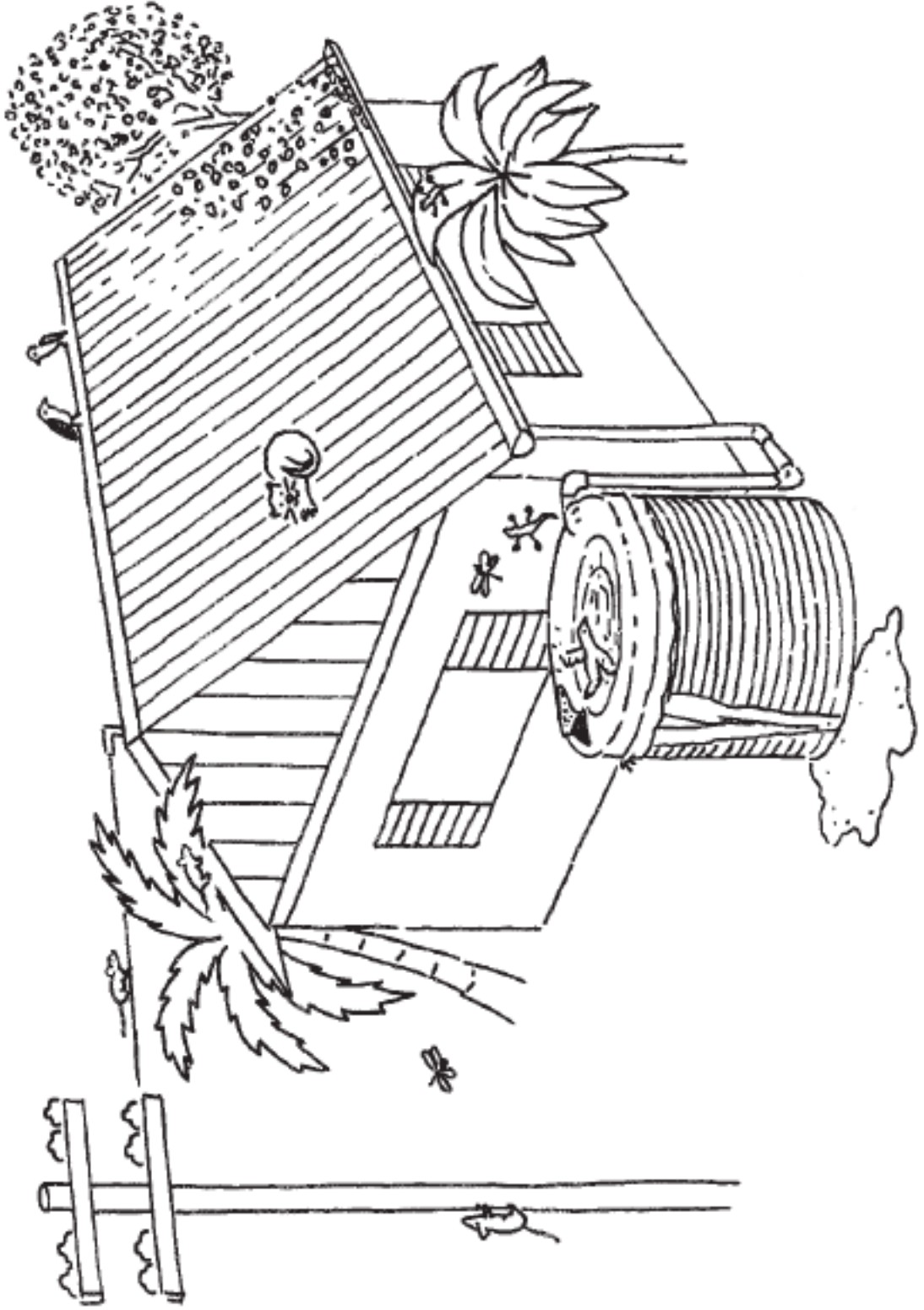

1. A torn or mesh cover on the tank; allows birds, rats and lizards to get in.
2. Overhanging trees and wires allows rats access to the roof; their feces and urine will contaminate the tank water.
3. Overhanging trees are littering the roof with leaves, which will contaminate the tank water.
4. Uncontrolled tank overflow undermines the tank's foundation, resulting in eventual collapse.
5. The downspout is improperly designed, and will hold stagnant water between rains where bacteria can grow.

This document was adapted by Portia K. Franz, former Palau Water Quality Coordinator at Palau Community College, from *Guidelines on Rainwater Catchment System for Hawaii*.

Macomber, Patricia S.H. 2001. *Guidelines on Rainwater Catchment System for Hawaii*. College of Tropical Agriculture and Human Resources, University of Hawaii at Manoa. Available at www2.ctahr.hawaii.edu/oc/freepubs/pdf/RM-12.pdf

The document was further edited by Luisa F. Castro and Patricia Macomber from the College of Tropical Agriculture and Human Resources for use in training workshops at Palau Community College, the College of Micronesia, and the College of the Marshall Islands.

This publication is supported by the Cooperative State Research, Education, and Extension Service, U.S. Department of Agriculture, National Integrated Water Quality Program, Under Agreement No. 2002-51130-0197, Sub Contract Y404185 through Southwest States & Pacific Islands Regional Water Quality Program.

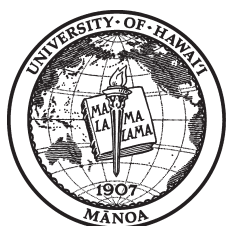

Dept. of Natural Resources and
Environmental Management
College of Tropical Agriculture and
Human Resources, Univ. of Hawaii
1910 East-West Rd.
Honolulu, HI 96822
Phone: (808) 956-8825
Fax: (808) 956-6539



The U.S. Department of Agriculture
Cooperative State Research,
Education, and Extension Service



The Southwest States and Pacific
Islands Region (EPA Region IX)



Palau Community College
P.O. Box 9
Koror, PW 96940
Phone: (680) 488-2746
Fax: (680) 488-3307



Palau Environmental Quality
Protection Board
P.O. Box 100
Koror, PW 96940
Phone: (680) 488-1639
Fax: (680) 488-2963
E-mail: eqpb@palaunet.com



Ministry of Health
Div. of Environmental Health
Bureau of Public Health
P.O. Box 6027
Koror, PW 96940
Phone: (680) 488-6073
Fax: (680) 488-6194